

17. Bank Protection

- 17.1. Introduction
- 17.2. Policy
- 17.3. Design Criteria
- 17.4. Bank and Lining Failure Modes
- 17.5. Revetment Types
- 17.6. Design Concept
- 17.7. Design Guidelines
- 17.8. References

17.1. Introduction

17.1.1 Purpose

One of the hazards of placing a highway near a river or stream channel or other water body is the potential for erosion of the highway embankment by moving water.

If erosion of the highway embankment is to be prevented, bank protection must be anticipated, and the proper type and amount of protection must be provided in the right locations.

Four methods of protecting a highway embankment from bank erosion are available to the designer. These are:

- relocating the highway away from the stream or water body,
- moving the water body away from the highway (channel change),
- changing the direction of the current with training works, and
- protecting the embankment from erosion.

This chapter provides procedures for the design of revetments to be used as channel bank protection and channel linings on larger streams and rivers. Procedures are also presented for riprap protection at bridge piers and abutments. For small discharges, procedures presented in the Channel Chapter should be used. Emphasis in this chapter has been placed on rock riprap revetments due to their costs, environmental considerations, flexible characteristics and widespread acceptance.

17.1.2 Erosion Potential

Channel and bank stabilization is essential to the design of any structure affected by the water environment. The identification of the potential for bank erosion, and the subsequent need for stabilization, is best accomplished through observation. Analytic methods are available for the evaluation of bank stability; however, they should only be used to confirm observations, or in cases where observed data are unavailable.

Observations provide the most positive indication of erosion potential. Observation comparison can be based on historic information, or current site conditions. Aerial photographs, old maps and surveying notes, and bridge design files and river survey data that are available at ADOT&PF and at Federal agencies, as well as gaging station records and interviews of long-time residents can provide documentation of any recent and potentially current channel movement or bank instabilities.

In addition, current site conditions can be used to evaluate stability. Even when historic information indicates that a bank has been relatively stable in the past, local conditions may indicate more recent instabilities. Local site conditions which are indicative of instabilities may include tipping and falling of vegetation along the bank, cracks along the bank surface, the presence of slump blocks, fresh vegetation laying in the channel near the channel banks, deflection of channel flows in the direction of the bank due to some recently deposited obstruction or channel course change, fresh vertical face cuts along the bank, locally high velocities along the bank, new bar formation downstream from an eroding bank, local headcuts, pending or recent cutoffs, etc. It is also important to recognize that the presence of any one of these conditions does not in itself indicate an erosion problem; some bank erosion is common in all channels even when the channel is stable.

17.1.3 Symbols and Definitions

To provide consistency within this chapter as well as through out this manual the following symbols will be used. These symbols were selected because of their wide use in many bank and shore protection publications. Where the same symbol is used for more than one definition, the symbol will be defined where it is used.

SYMBOLS AND DEFINITIONS

<u>Symbol</u>	<u>Definition</u>	English <u>Units</u>	Metric <u>Units</u>
C	Coefficient that relates free vortex motion to velocity streamlines for unequal radius of curvature	-	-
D ₅₀	The median bed material size	ft	m
D ₁₅	The fifteen percent finer particle size	ft	m
D ₈₅	The eighty-five percent finer particle size	ft	m
d _{avg}	Average flow depth in the main flow channel	ft	m
d _s	Estimated probable maximum depth of scour	ft	m
g	Gravitational acceleration (32.2 ft/s ² , 9.81 m/s ²)	ft/s ²	m/s ²
H	Wave height	ft	m
K ₁	Correction term reflecting bank angle	-	-
n	Manning's roughness coefficient	-	-
Q _{mc}	Discharge in the zone of main channel flow	cfs	cms
R	Hydraulic radius	ft	m
R	Wave runup	ft	m
R _o	Mean radius of the channel centerline at the bend	ft	m
S _f , S	Friction slope or energy grade line slope	ft/ft	m/m
SF	Stability factor	-	-
S _s , S	Specific gravity of the riprap material	-	-
T	Topwidth of the channel between its banks	ft	m
V	Velocity	ft/s	m/s
V _a	Mean channel velocity	ft/s	m/s
W ₅₀	Weight of the median particle	lb	kg
Z	Superelevation of the water surface	ft	m
Γ	Unit weight of the riprap material	lb/ft ³	kg/m ³
Θ	Bank angle with the horizontal	degrees	degrees
Φ	Riprap materials angle of repose	degrees	degrees

conditions thus protecting and maintaining the environment.

17.2. Policy

Highway alignments and improvements often cross, encroach upon or otherwise impact the river environment both upstream and downstream of the site. It is necessary to protect the public, the highway investment and the environment from the natural reaction to the highway changes. ADOT&PF policy requires that the facility, including bank protection, will perform without significant damage or hazard to people and property for flood and flow conditions experienced up to the design flood. The facility, to the maximum extent possible, shall perpetuate natural drainage

17.3. Design Criteria

To provide an acceptable standard level of service, the Department traditionally employs widely used pre-established design frequencies which are based on the importance of the transportation facility to the system and the allowable risk for that facility. This would be true of revetment protection. Selection of the appropriate design condition from these standards is a matter of professional judgment, since it is rarely either possible or practical to provide protection for the greatest probable flow. The Department's Design Flow Frequencies are given Appendix A of Chapter 7, Hydrology. However, although the design flow

frequency standards represent the engineering consensus on reasonable values, actual design must consider consequences of any other event which may produce a more severe hydraulic condition. Under certain conditions, it may be appropriate to establish the level of risk allowable for a site and to design to that level. In addition, design standards of other agencies that have control or jurisdiction over the waterway or facility concerned should be incorporated or addressed in the design. Specific design criteria recommendations are summarized below and are presented in greater detail in Section 17-6.

<u>Minimum Criteria</u>	<u>Frequency</u>
Design Flow	10 - 100 year flood
Freeboard at Design Flow	1 foot, minimum, depending on velocity, debris, ice, and other considerations.
Check Flow	25 - 500 year flood
Freeboard at Check Flow	0 foot

For clarification, it should be noted that design flood frequency (given as a recurrence interval, e.g. 50-year flood) does not equate to bank protection design life. Recurrence interval is merely the reciprocal of the probability of exceedence in a given year.

17.4. Bank and Lining Failure Modes

17.4.1 Potential Failures

Prior to designing a bank stabilization scheme, it is important to be aware of common erosion mechanisms and revetment failure modes, and the causes or driving forces behind bank erosion processes. Inadequate recognition of potential erosion processes at a particular site may lead to failure of the revetment system.

Many causes of bank erosion and revetment failure have been identified. Some of the more common include abrasion, debris flows, water flow, eddy action, flow acceleration, unsteady flow, freeze/thaw, human actions on the bank, ice, precipitation, waves, toe erosion, and subsurface flows. However, it is most often a combination of mechanisms which cause bank and revetment failure, and the actual mechanism or cause is usually difficult to determine. Failures are better classified by failure mode including:

- particle erosion,
- translational slide,

- modified slump, and
- slump

17.4.2 Particle Erosion

Particle erosion is the most commonly considered erosion mechanism. Particle erosion results when the tractive force exerted by the flowing water exceeds the bank material's ability to resist movement. In addition, if displaced stones are not transported from the eroded area, a mound of displaced rock will develop on the channel bed. This mound has been observed to cause flow concentration along the bank, resulting in further bank erosion.

A special type of particle erosion results in loss of the underlying material resulting in undermining and eventual collapse of the revetment protection. Usually the underlying material is lost through the revetment or piped under the toe of the revetment protection. This failure is very common in and extremely damaging to rigid types of protective linings. Providing a suitable filter, either natural or fabrics in conjunction with hydrostatic relief features will prevent this failure.

Another frequent type of particle erosion failure occurs at the edges of the protective feature. The interface creates turbulence which in turn increases the tractive stresses placed on the protective layer, underlying layers, and the natural bank material beyond the revetment. This failure area needs to receive special attention since extension of the protective feature usually only moves, not eliminates, the failure.

17.4.3 Translation Slide

A translational slide is a failure of riprap caused by the downslope movement of a mass of stones, with the fault line on a horizontal plane. The initial phases of a translational slide are indicated by cracks in the upper part of the riprap bank that extend parallel to the channel. As the slide progresses, the lower part of riprap separates from the upper part, and moves downslope as a homogeneous body. A resulting bulge may appear at the base of the bank if the channel bed is not scoured

17.4.4 Modified Slump

The failure of riprap referred to as modified slump is the mass movement of material along an internal slip surface within the riprap blanket; the underlying material supporting the riprap does not fail. This type of failure is similar in many respects to the translational slide, but the geometry of the damaged riprap is similar

in shape to initial stages of failure caused by particle erosion.

17.4.5 Slump

Slump is a rotational-gravitational movement of material along a surface of rupture that has a concave upward curve. The cause of slump failures is related to shear failure of the underlying base material that supports the riprap revetment. The primary feature of a slump failure is the localized displacement of base material along a slip surface, which is usually caused by excess pore pressure that reduces friction along a fault line in the base material.

17.5. Revetment Types

17.5.1 Types

The types of slope protection or revetment commonly used for bank and shore protection and stabilization include:

- rock and rubble riprap,
- wire-enclosed rock (gabions),
- pre-formed blocks,
- grouted rock,
- paved lining (concrete slope pavement),
- grouted fabric,
- sand/cement bags, and
- soil cement.

Descriptions of each of these revetment types are included in this section.

17.5.2 Riprap

Riprap has been described as a layer or facing of rock, dumped or hand-placed to prevent erosion, scour, or sloughing of a structure or embankment. Materials other than rock are also referred to as riprap; for example, rubble, broken concrete slabs, and preformed concrete shapes (slabs, blocks, rectangular prisms, etc.). These materials are similar to rock in that they can be hand-placed or dumped onto an embankment to form a flexible revetment. This is the most common and generally the most economical and maintenance free revetment type used in Alaska.

17.5.3 Wire-Enclosed Rock

Wire-enclosed rock, or gabion, revetments consist of rectangular wire mesh baskets filled with rock. These revetments are formed by filling pre-assembled wire baskets with rock, and anchoring to the channel bottom or bank. Wire-enclosed rock revetments are generally of two types distinguished by shape: rock and wire mattresses, or blocks. In mattress designs, the individual wire mesh units are laid end to end and side to side to form a mattress layer on the channel bed or bank. The gabion baskets comprising the mattress generally have a depth dimension which is much smaller than their width or length. Block gabions, on the other hand, are more equal-dimensional, having depths that are approximately the same as their widths, and of the same order of magnitude as their lengths. They are typically rectangular or trapezoidal in shape. Block gabion revetments are formed by stacking the individual gabion blocks in a stepped fashion. Wire enclosed rock can be subject to failure due to ice, debris, and settlement.

17.5.4 Pre-cast Concrete Block

Pre-cast concrete block revetments are a recent development. The pre-formed sections which comprise the revetment systems are butted together or joined in some fashion; as such, they form a continuous blanket or mat. The concrete blocks which make up the mats differ in shape and method of articulation, but share certain common features. These features include flexibility, rapid installation, and provisions for establishment of vegetation within the revetment. The permeable nature of these revetments permits free draining of the bank materials; the flexibility, although limited, allows the mattress to conform to minor changes in the bank geometry. Their limited flexibility, however, makes them subject to undermining in environments characterized by large and relatively rapid fluctuations in the surface elevation of the channel bed and/or bank. This type of revetment may also be subject to damage due to wave action. Unlike wire-enclosed rock, the open nature of the pre-cast concrete blocks does promote volunteering of vegetation within the revetment.

17.5.5 Grouted Rock

Grouted rock revetment consists of rock slope-protection having voids filled with concrete grout to form a monolithic armor. Grouted rock is a rigid revetment; it will not conform to changes in the bank geometry due to settlement. As with other monolithic revetments, grouted rock is particularly susceptible to

failure from frost action and undermining with the subsequent loss of the supporting bank material. Although it is rigid, grouted rock is not extremely strong: therefore, the loss of even a small area of bank support can cause failure of large portions of the revetment.

17.5.6 Concrete Slope Protection

Concrete pavement revetments (concrete slope pavement) are cast in place on a prepared slope to provide the necessary bank protection. Like grouted rock, concrete pavement is a rigid revetment which does not conform to changes in bank geometry due to a removal of foundation support by subsidence, undermining, outward displacement by hydrostatic pressure and frost, slide action, or erosion of the supporting embankment at its ends. The loss of even small sections of the supporting embankment can cause complete failure of the revetment system. Concrete pavement revetments are also among the most expensive streambank protection designs. In the past, concrete pavement has been best utilized as a subaqueous revetment (on the bank below the water surface) with vegetation or some other less expensive upper-bank treatment.

17.5.7 Grouted Fabric Slope Protection

Grouted fabric slope protection revetments are constructed by injecting sand-cement mortar between two layers of double-woven fabric which has first been positioned on the slope to be protected. Mortar may be injected into this fabric envelope either underwater or in-the-dry. The fabric enclosure prevents dilution of the mortar during placement underwater. The two layers of fabric act first as the top and bottom form to hold the mortar in place while it hardens. This fabric, to which the mortar remains tightly bonded, then acts as tensile reinforcing to hold the mortar in place on the slope. The fabric layers may be sewn to form pillows or tubes. These revetments are analogous to slope paving with reinforced concrete, although may be somewhat flexible. The bottom layer of fabric acts as a filter cloth underlayment to prevent loss of soil particles through any cracks which may develop in the revetment as a result of soil subsidence. Often greater relief of hydrostatic uplift is provided by weep holes or filter points which are normally woven into the fabric and remain unobstructed by mortar during the filling operation.

17.5.8 Sand-Cement Bags

Sand cement bags generally consist of a dry mix of sand and cement placed in a burlap or other suitable bag. They are handplaced in contact with adjacent bags. They require firm support from the protected bank. The loss of even a small area of bank support can cause failure of large portions of the revetment. Usually a filter fabric is placed underneath this type of revetment. Adequate protection of the terminals and toe is essential. This type of revetment has little flexibility, low tensile strength and is susceptible to damage particularly on flatter slopes where the area of contact between the bags is less. Experience has shown that this type of bank protection is susceptible to failure due to ice forces.

17.5.9 Soil Cement

Soil-cement generally consists of a dry mix of sand and cement and admixtures batched in a central mixing. It is usually transported, placed by equipment capable of producing the width and thickness required and compacted to the required density. Control of the moisture and time after introduction of the mixing water is critical. Curing is required. This results in a rigid protection. Soil-cement can be placed either as a lining or in stepped horizontal layers. The stepped horizontal layers are extremely stable provided toe scour protection has been incorporated in the design. This type of revetment exhibits similar failure characteristics as concrete slope protection. It is generally not recommended for use in Alaska for bank protection.

17.6. Design Concepts

17.6.1 Introduction

Design concepts related to the design of bank protection are discussed in this section. Subjects covered in this section include design discharge, flow types, section geometry, flow in channel bends, flow resistance, and extent of protection.

17.6.2 Design Discharge

Design flow rates for the design or analysis of highway structures in the vicinity of rivers and streams usually have a 10 to 50-year recurrence interval. In most cases, these discharge levels will also be applicable to the design of revetment systems. However, the designer should be aware that in some instances, a lower discharge may produce hydraulically worse conditions with respect to riprap stability. It is suggested that a range of discharge levels be evaluated to ensure that the

design is adequate for all discharge conditions up to that selected as the design discharge for structures associated with the protection scheme.

17.6.3 Flow Types

Open channel flow can be classified from three points of reference. These are:

- uniform, gradually varying, or rapidly varying flow;
- steady or unsteady flow; and
- subcritical or supercritical flow.

Design relationships presented in this chapter are based on the assumption of uniform, steady, subcritical flow.

These relationships are also valid for gradually varying flow conditions. While the individual hydraulic relationships presented are not in themselves applicable to rapidly varying, unsteady, or supercritical flow conditions, procedures are presented for extending their use to these flow conditions (see the Channel chapter for more details related to channel design).

Rapidly varying, unsteady flow conditions are common in areas of flow expansion, flow contraction, and reverse flow. These conditions are common at and immediately downstream of bridges. Supercritical or near supercritical flow conditions are common at bridge constrictions and on steep sloped channels.

Non-uniform, unsteady, and near supercritical flow conditions create stresses on the channel boundary that are significantly different from those induced by uniform, steady, subcritical flow. These stresses are difficult to assess quantitatively. The stability factor method of riprap design presented in Section 17.7.1 provides a means of adjusting the final riprap design (which is based on relationships derived for steady, uniform, subcritical flow) for the uncertainties associated with these other flow conditions. The adjustment is made through the assignment of a stability factor. The magnitude of the stability factor includes the level of uncertainty inherent in the design flow conditions.

17.6.4 Section Geometry

Design procedures presented in this chapter require as input channel cross-section geometry. The cross section geometry is necessary to establish the hydraulic design parameters (such as flow depth, topwidth, velocity, hydraulic radius, etc.) required by the

protection design procedures, as well as to establish a construction cross section for placement of the revetment material. When the entire channel perimeter is to be stabilized, the selection of an appropriate channel geometry is only a function of the desired channel conveyance properties and any limiting geometric constraints. However, when the channel bank alone is to be protected, the design must consider the existing channel bottom geometry.

The development of an appropriate channel section for analysis is very subjective. The intent is to develop a section which reasonably simulates a worst case condition with respect to protection stability.

Information which can be used to evaluate channel geometry includes current channel surveys, past channel surveys (if available), and current and past aerial photos. In addition, the effect channel stabilization will have on the local channel section must be considered.

The first problem arises when an attempt is made to establish an existing channel bottom profile for use in design. A single channel profile is usually not enough to establish the design cross section. In addition to current channel surveys, historic surveys can provide valuable information. A comparison of current and past channel surveys at the location provides information on the general stability of the site, as well as a history of past channel geometry changes. Often, past surveys at a particular site will not be available. If this is the case, past surveys at other sites in the vicinity of the design location may be used to evaluate past changes in channel geometry.

17.6.5 Flow in Channel Bends

Flow conditions in channel bends are complicated by the distortion of flow patterns in the vicinity of the bend. In long, relatively straight channels, the flow conditions are uniform, and symmetrical about the center line of the channel. However, in channel bends, the centrifugal forces and secondary currents produced lead to non-uniform and non-symmetrical flow conditions.

Special consideration must be given to the increased velocities and shear stresses that are generated as a result of non-uniform flow in bends.

Superelevation of flow in channel bends is another important consideration in the design of revetments. Although the magnitude of superelevation is generally small when compared with the overall flow depth in the bend (usually less than one foot) it should be

considered when establishing freeboard limits for bank protection schemes on sharp bends. The magnitude of superelevation at a channel bend may be estimated for subcritical flow by the following equation:

$$Z = C [(V_a^2 T)/(g R_o)] \quad (17.1)$$

where:

- Z = superelevation of the water surface, ft
 C = coefficient that relates free vortex motion to velocity streamlines for unequal radius of curvature,
 V_a = mean channel velocity, ft/s
 T = water-surface width at section, ft
 g = gravitational acceleration - 32.2 ft/s², ft/s²
 R_o = the mean radius of the channel centerline at the bend, ft

The coefficient C has been evaluated by the U.S. Geological Survey (U.S.G.S.) and ranges between 0.5 and 3.0, with an average value of 1.5.

17.6.6 Flow Resistance

The hydraulic analysis performed as a part of the protection design process requires the estimation of Manning's roughness coefficient. Physical characteristics upon which the resistance equations are based include the channel base material, surface irregularities, variations in section geometry, obstructions, vegetation, channel meandering, flow depth, and channel slope. In addition, seasonal changes in these factors must also be considered. See Channels Chapter, for a discussion of the selection of Manning's n values.

17.6.7 Extent of Protection

Extent of protection refers to the longitudinal and vertical extent of protection required to adequately protect the channel bank.

Longitudinal Extent

The longitudinal extent of protection required for a particular bank protection scheme is highly dependent on local site conditions. In general, the revetment should be continuous for a distance greater than the length of the area to be protected. Although this is a vague criteria, it demands serious consideration. Review of existing bank protection sites has revealed that a common misconception in streambank protection

is to provide protection too far upstream and not far enough downstream.

One criteria for establishing the longitudinal limits of protection required is illustrated in Figure 17-1 on the next page. As illustrated, the minimum distances recommended for bank protection are an upstream distance of 1.0 channel width and a downstream distance of 1.5 channel widths from corresponding reference lines. All reference lines pass through tangents to the bend at the bend entrance or exit. This criteria is based on analysis of flow conditions in symmetric channel bends under ideal laboratory conditions. Real-world conditions are rarely as simplistic.

In actuality, many site-specific factors have a bearing on the actual length of bank that should be protected. A designer will find the above criteria difficult to apply on mildly curving bends or on channels having irregular, non-symmetric bends. Also, other channel controls (such as bridge abutments) might already be producing a stabilizing effect on the bend so that only a part of the channel bend needs to be stabilized. In addition, the magnitude or nature of the flow event might only cause erosion problems in a very localized portion of the bend, requiring that only a short channel length be stabilized. Therefore, the above criteria should only be used as a starting point. Additional analysis of site-specific factors is necessary to define the actual extent of protection required.

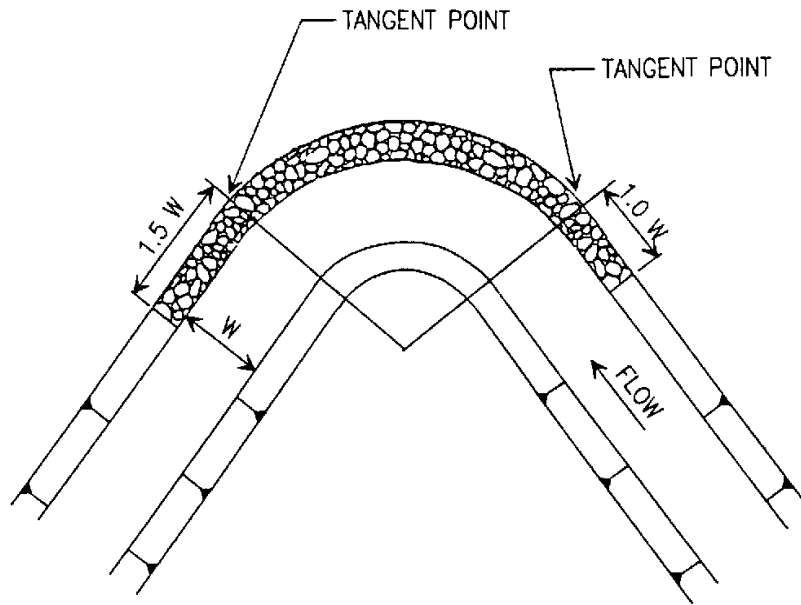

Figure 17-1
Longitudinal Extent of Revetment Protection

Field reconnaissance is a useful tool for the evaluation of the longitudinal extent of protection required, particularly if the channel is actively eroding. In straight channel reaches, scars on the channel bank may be useful to help identify the limits required for channel bank protection. In this case, it is recommended that upstream and downstream limits of the protection scheme be extended a minimum of one channel width beyond the observed erosion limits.

In curved channel reaches, the scars on the channel bank can be used to establish the upstream limit of erosion. Here a minimum of one channel width should be added to the observed upstream limit to define the limit of protection. The downstream limit of protection required in curved channel reaches is not as easy to define. Since the natural progression of bank erosion is in the downstream direction, the present visual limit of erosion might not define the ultimate downstream limit. Additional analysis based on consideration of flow patterns in the channel bend may be required.

Vertical Extent

The vertical extent of protection required of a revetment includes design height and foundation or toe depth.

Design Height

In general, the design height of a protection installation should be equal to the design highwater elevation plus some allowance for freeboard. Freeboard is provided to ensure that the desired degree of protection will not be reduced by unaccounted factors. Some such factors include:

- wave action (from wind or boat traffic),
- superelevation in channel bends,
- hydraulic jumps, and
- flow irregularities due to piers, transitions, and flow junctions.

In addition, erratic phenomena such as unforeseen embankment settlement, the accumulation of silt, trash, and debris in the channel, aquatic or other growth in the channels, and ice flows should be considered when

setting freeboard heights. Also, wave run-up on the bank must be considered.

The prediction of wave heights from wind and boat generated waves is not as straightforward as other wave

sources. Figure 17-2 provides a definition sketch for the wave height discussion to follow. The height of boat generated waves must be estimated from observations. The height of wind generated waves is discussed in the Coastal Chapter.

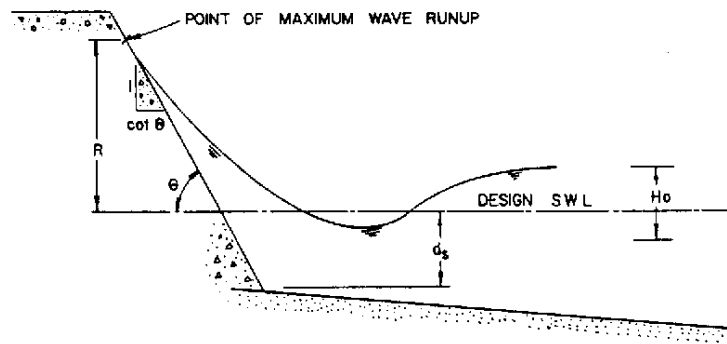
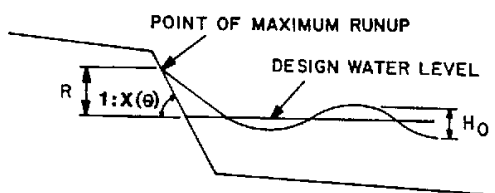

Figure 17-2
Wave Height Definition Sketch

It is necessary to estimate the magnitude of wave runup which results when waves impact the bank. Wave runup is a function of the design wave height, the wave period, bank angle, and the bank surface characteristics (as represented by different revetment materials). For wave heights less than 2 ft, wave runup can be computed using Figure 17-3 and Table 17-1. The runup height (R) given in Figure 17-3 is for concrete pavement. Correction factors are provided in Table 17-1 for reducing the runup magnitude for other revetment materials. The correction factor is multiplied times the wave height to get the resulting wave runup (R).

**Table 17-1
Correction Factors For Wave Run-Up**

<u>Slope Surface Characteristics</u>	<u>Placement Method</u>	<u>Correction Factor</u>
Concrete pavement	---	1.00
Concrete blocks(voids < 20%)	fitted	0.90
Concrete blocks(20% < voids > 40%)	fitted	0.70
Concrete blocks(40% < voids > 60%)	fitted	0.50
Grass	---	0.85 - 0.90
Rock riprap (angular)	random	0.60
Rock riprap (round)	random	0.70
Rock riprap (handplaced or keyed)	keyed	0.80
Grouted rock	---	0.90
Wire enclosed rocks/gabions	---	0.80



R = WAVE RUN UP HEIGHT (ft)
 H_0 = WAVE HEIGHT (ft)
 θ = BANK ANGLE WITH THE HORIZONTAL

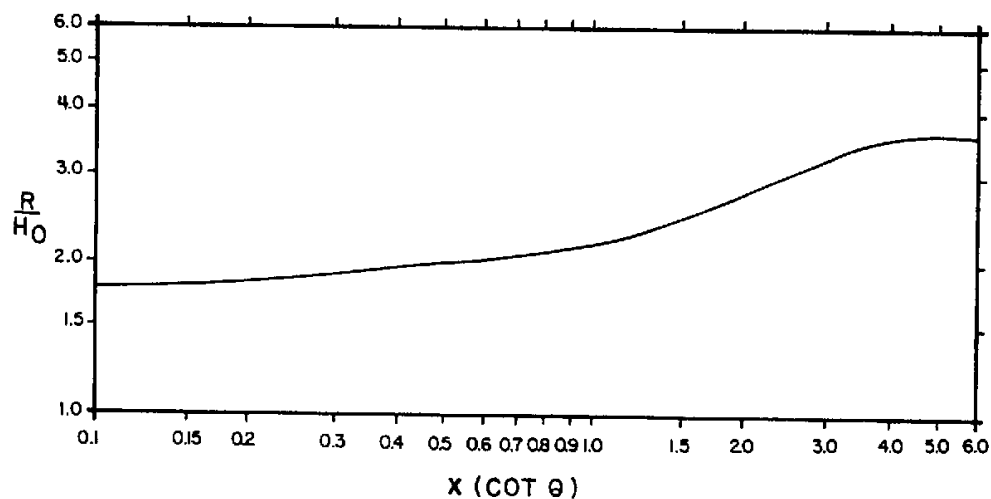

**Figure 17-3
Wave Run-Up On Smooth, Impermeable Slopes**

As indicated, there are many factors which must be considered in the selection of an appropriate freeboard height. As a minimum, it is recommended that a freeboard elevation of 1 to 2 feet be used in unconstricted reaches, and 2 feet in constricted reaches. The Federal Emergency Management Agency requires 3 feet for levee protection and 4 feet at bridges for the 100-year flood. When computational procedures indicate that additional freeboard may be required, the greater height should be used. In addition, it is recommended that the designer observe wave and flow conditions during various seasons of the year (if possible), consult existing records, and interview persons who have knowledge of past conditions when establishing the necessary vertical extent of protection required for a particular revetment installation.

Toe Depth

The undermining of revetment toe protection has been identified as one of the primary mechanisms of revetment failure. In the design of bank protection, estimates of the depth of scour are needed so that the protective layer is placed sufficiently low in the streambed to prevent undermining. The ultimate depth of scour must consider channel degradation as well as natural scour and fill processes.

The relationships presented in Equation 17.2 and 17.3 can be used to estimate the probable maximum depth of scour due to natural scour and fill phenomenon in straight channels, and in channels having mild bends. In application, the depth of scour, d_s , should be measured from the lowest elevation in the cross section. It should be assumed that the low point in the cross section may eventually move adjacent to the protection (even if this is not the case in the current survey).

$$d_s = 12 \text{ ft} \quad \text{for } D_{50} < 0.005 \text{ ft} \quad (17.2)$$

$$d_s = 6.5 D_{50}^{-0.11} \quad \text{for } D_{50} > 0.005 \text{ ft} \quad (17.3)$$

where:

d_s = estimated probable maximum depth of scour, ft

D_{50} = median diameter of bed material, ft

The depth of scour predicted by Equations 17.2 and 17.3 must be added to the magnitude of predicted degradation and local scour (if any) to arrive at the total required toe depth.

17.7. Design Guidelines

17.7.1 Rock Riprap

Historically, the department has used “Bank and Shore Protection in California Highway Practice (a.k.a. California Bank and Shore) for rock riprap design guidelines with good results. While this publication is out of print, the guidelines and procedures remain accepted practice. The FHWA provide guidelines and procedures in HEC-11, “Design of slope, rock size, rock gradation, riprap layer thickness, filter design, edge treatment, and construction considerations. In most cases, the guidelines presented apply equally to rock and rubble riprap.

Bank Slope

A primary consideration in the design of stable riprap bank protection schemes is the slope of the channel bank. For riprap installations, normally the maximum recommended face slope is 2:1. Although it is generally not recommended, the steepest slope acceptable for rubble revetment is 1.5:1. To be stable under an identical wave attack or lateral velocity, a rubble revetment with a steep slope will need larger rubble sizes and greater thickness than one with a flatter slope.

Rock Size

The stability of a particular riprap particle is a function of its size, expressed either in terms of its weight or equivalent diameter. Specific design guidelines may be found in “California Bank and shore, and HEC-11.”

Ice Damage

Ice can affect riprap linings in a number of ways. Moving surface ice can cause crushing and bending forces as well as large impact loadings. The tangential flow of ice along a riprap lined channel bank can also cause excessive shearing forces. Quantitative criteria for evaluating the impact ice has on channel protection schemes are unavailable. However, historic observations of ice flows in New England rivers indicate that riprap sized to resist design flow events will also resist ice forces.

For design, consideration of ice forces should be evaluated on a case by case basis. In most instances, ice flows are not of sufficient magnitude to warrant detailed analysis. Where ice flows have historically the selection of an appropriate stability factor to

account for ice generated erosive problems should be based on local experience.

Rock Gradation

The gradation of stones in riprap revetment affects the riprap’s resistance to erosion. The stone should be

reasonably well graded throughout the riprap layer thickness. The gradation limits should not be so restrictive that production costs would be excessive. Table 17-2 presents six gradation classes based on AASHTO specifications.

**Table 17-2
Riprap Graduation Classes**

Riprap Class	Rock Size ¹ (W) (lbs.)	Rock Size ² (D) (ft.)	Percent of Riprap Smaller Than
A	200	1.30	100
	75	0.95	50
	5	0.40	10
B	500	1.80	100
	200	1.30	50
	5	0.40	10
C	1000	2.25	100
	5000	1.80	50
	75	0.95	10
D	2000	2.85	100
	1000	2.25	50
	500	1.80	5
E	4000	3.6	100
	2000	2.85	50
	1000	2.25	5
F	8000	4.5	100
	4000	3.6	50
	2000	2.85	5

1 Based on AASHTO gradations

2 Equivelent diameter of a sphere assuming a specific gravity of 2.65

If specific gravity is not equal to 2.65 then convert using: $D_{adj} = D(2.65/S)$

Layer Thickness

All stones should be contained reasonably well within the riprap layer thickness to provide maximum resistance against erosion. Oversize stones, even in isolated spots, may cause riprap failure by precluding mutual support between individual stones, providing large voids that expose filter and bedding materials, and creating excessive local turbulence that removes smaller stones. Small amounts of oversize stone should be removed individually and replaced with proper size stones. The following criteria apply to the riprap layer thickness.

- It should not be less than the equivalent spherical diameter of the D_{100} stone, or less than 2.0 times the spherical diameter of the D_{50} stone, whichever results in the greater thickness, rounded to the next foot.
- The thickness determined above should be increased by 50 percent when the riprap is placed underwater to provide for uncertainties associated with this type of placement.
- An increase in thickness of one foot, accompanied by an appropriate increase in stone sizes, should be provided where riprap revetment will be subject to attack by floating debris or ice, or by waves from boat wakes, wind, or bedforms.

Quantity Estimates

Design quantity estimates of rock riprap are based on weight / volume relationships. These relationships are a function of material shape, density, and method of placement. The Regional Materials Engineer shall provide a conversion factor for placed volume versus pit yield (lbs/yd³).

Filter Design

A filter is a transitional layer of gravel, small stone, or fabric placed between the underlying soil and the structure. A filter should be used whenever the riprap is placed on noncohesive material subject to significant subsurface drainage (such as in areas where water surface levels fluctuate frequently and in areas of high groundwater levels).

Granular Filters

Granular filters have several advantages. Use of in-situ material may be possible if the grain size distribution meets the design criteria. Granular filters may be easier to place underwater than fabric, may be less susceptible

to damage during placement, and are less susceptible to damage from hydrostatic pressure. However, granular filters can be more costly to place, material may not be locally available, and may perform poorly in silt-bed rivers. See "California Bank and Shore or HEC-11 for specific design guidelines.

Fabric Filters

Synthetic fabric filters have found considerable use as alternatives to granular filters. The following list of advantages relevant to using fabric filters have been identified.

- Installation is generally quick and labor-efficient.
- Fabric filters are more economical than granular filters.
- Fabric filters have consistent and more reliable material quality.
- Fabric filters have good inherent tensile strength.
- Local availability of suitable granular filter material is no longer a design consideration when using fabric filters.

Disadvantages include the following.

- Filter fabrics can be difficult to lay underwater.
- Installation of some fabrics must be undertaken with care to prevent undue ultraviolet light exposure.
- Bacterial activity within the soil or upon the filter can control the hydraulic responses of a fabric filter system.
- Experimental evidence indicates that when channel banks are subjected to wave action, non-cohesive bank material has a tendency to migrate downslope beneath fabric filters; this tendency was not observed with granular filters.
- Fabric filters may induce translational or modified slump failures when used under rock riprap installed on steep slopes.

Filter Fabric Design

The filter cloth (geotextile) design should consider the following performance areas.

- Soil Retention (Piping Resistance)
- Permeability
- Clogging
- Survivability

It is extremely desirable that individual site requirements be used to establish the necessary requirements. Generalized geotextile requirements should be used only on very small or non-critical/non-severe installations where a detailed analysis is not warranted. A detailed description of the above special considerations is provided in the FHWA Geotextile Engineering Manual.

Edge Treatment

The edges of riprap revetments (flanks, toe, and head) require special treatment to prevent undermining.

The flanks of the revetment should be designed as illustrated in Figure 17-4. The upstream flank is illustrated in section (a) and the downstream flank in section (b) of this figure. A more constructible flank section uses riprap rather than compacted fill.

Undermining of the revetment toe is one of the primary mechanisms of riprap failure. The toe of the riprap should be designed as illustrated in Figure 17-5. The toe material should be placed in a toe trench along the entire length of the riprap blanket.

Where a toe trench cannot be dug, the riprap blanket should terminate in a thick, stone toe at the level of the streambed (see alternate design in Figure 17-5). Care must be taken during the placement of the stone to ensure that the toe material does not mound and form a low dike; a low dike along the toe could result in flow concentration along the revetment face which could stress the revetment to failure. In addition, care must be exercised to ensure that the channel's design capability is not impaired by placement of too much riprap in a toe mound.

The size of the toe trench or the alternate stone toe is controlled by the anticipated depth of scour along the revetment. As scour occurs (and in most cases it will) the stone in the toe will launch into the eroded area as illustrated in Figure 17-6. Observation of the performance of these types of rock toe designs indicates

that the riprap will launch to a final slope of approximately 2:1.

The volume of rock required for the toe must be equal to or exceed one and one-half times the volume of rock required to extend the riprap blanket (at its design thickness and slope) to the anticipated depth of scour. The alternate placement location may be used when the amount of rock required would not constrain the channel or cause unacceptable environmental impacts. Establishing a design scour depth is covered in section 17.6.7.

Edge Treatment
(continued)

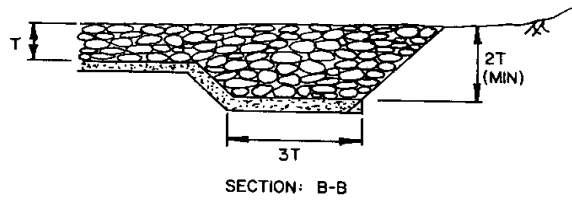
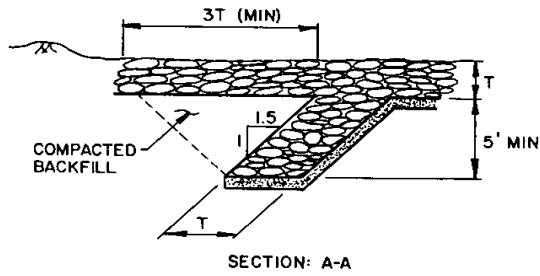
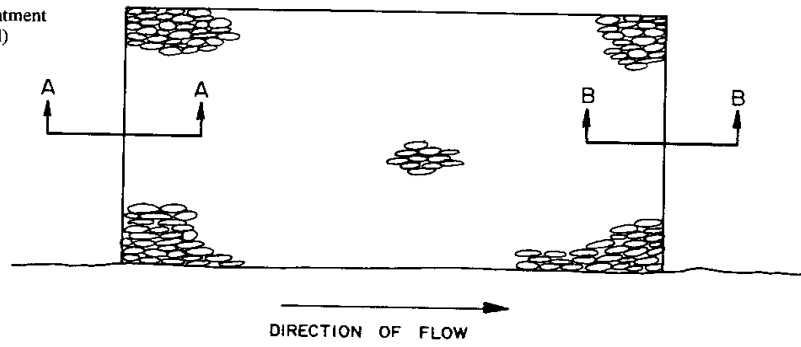

Figure 17-4
Typical Riprap Installation: Plan And Flank Details

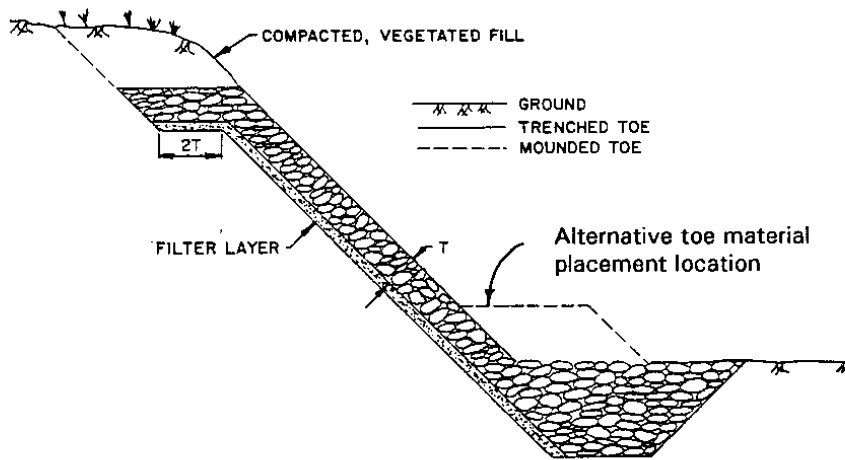

Figure 17-5
Typical Riprap Installation: End View (Bank Protection Only)

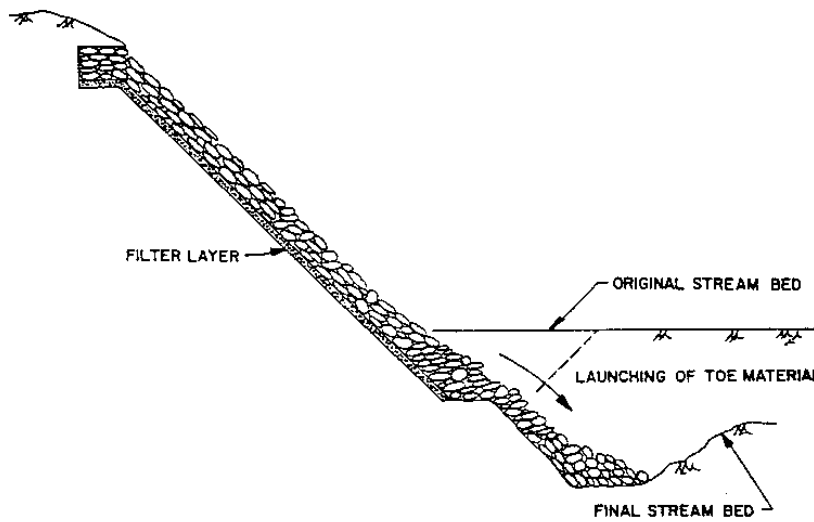

Figure 17-6
Launching of Riprap Toe Material

Construction Specification Considerations

Construction considerations related to the construction of riprap revetments include bank slope or angle, bank preparation, riprap placement, and permit requirements.

Bank Preparation

In general, the bank should be prepared by first clearing all trees and debris from the bank, and grading the bank surface to the desired slope. The graded surface should not deviate from the specified slope line by more than 6 inches. However, local depressions larger than this can be accommodated using a granular filter since initial placement of filter material and/or rock for the revetment will fill these depressions. Any large boulders or debris found buried near the edges of the revetment should be removed.

Riprap Placement

The common methods of riprap placement are hand placing; machine placing, such as from a skip, dragline, or some form of bucket; and dumping from trucks and spreading by bulldozer. Hand placement produces the best riprap revetment, but it is the most expensive method except when labor is unusually cheap. Where steep slopes are unavoidable, hand placement should be considered. Placement with a backhoe if properly performed may be considered equivalent to hand placement.

In the machine placement method, sufficiently small increments of stone should be released as close to their final positions as practical. Rehandling or dragging operations to smooth the revetment surface tend to result in segregation and breakage of stone, and can result in a rough revetment surface. Stone should not be dropped from an excessive height as this may result in the same undesirable conditions. Riprap placement by dumping and spreading is the least desirable method as a large amount of segregation and breakage can occur and is not recommended. Riprap placement by dumping with spreading may be satisfactory provided the required layer thickness is achieved. In some cases, it may be economical to increase the layer thickness and stone size somewhat to offset the shortcomings of this placement method.

Design Procedure

Rock riprap design procedure outlined in the following sections is comprised of three primary sections: preliminary data analysis, rock sizing, and revetment detail design. The individual steps in the procedure are numbered consecutively throughout each of the

sections. Figures 17-7 and 17-8 provide a useful format for recording data at each step of the analysis. Refer to California Bank and Shore or HEC-11 for design details.

Preliminary Data

Step 1- Compile all necessary field data including (channel cross section surveys, soils data, aerial photographs, history of problems at site, etc.).

PROJECT DESCRIPTION _____

Prepared by/Date: _____ / _____
 Checked by/Date: _____ / _____
 Sheet _____ of _____

Definition Sketch:

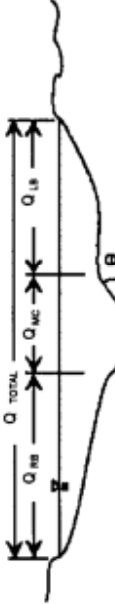

Soil Characteristics:
 Q_{TOTAL} _____
 Q_{MC} _____
 Q_{LS} _____
 Q_{RB} _____
 D_{15} _____
 D_{50} _____
 D_{85} _____

DEPTH OR W.S. (m)	A (m ²)	V_g (m/s)	d_a (m)	e	ϕ	K_1	D_{50} (mm)	SF	S_b	C	C_{PK}	D_{50} (mm)	NOTES
1	2	3	4	5	6	7	8	9	10	11	12	13	14

Design Sketch:

RIPRAP CHARACTERISTICS:
 Size: D_{10} _____ $2D_{50}$ _____
 Class: _____ D_{100} _____
 AASHTO Gradation: Size: _____
 (mm) _____
 Use: _____
 Percent Finer: _____
 100 _____
 50 _____
 5-10 _____

FABRIC CHARACTERISTICS:
 Granular: Size (mm) _____
 Finer _____
 85 _____
 50 _____
 15 _____
 Fabric: AOS < _____
 Perm. > _____
 Average Opening Size _____

- 1 Water surface elevation
- 2 Main channel flow area
- 3 Main channel average velocity
- 4 Main channel average depth
- 5 Bank angle
- 6 Riprap angle of repose (Figure 17-7)
- 7 Bank angle correction (Figure 17-6)
- 8 Riprap size (Figure 17-5)
- 9 Stability factor
- 10 Riprap specific gravity
- 11 Riprap size correction factor (Figure 17-8)
- 12 Pierisubement correction (3.38 if applicable)
- 13 Correction $D_{50} = 8 \times 11 \times 12$
- 14 Notes or comments

Figure 17-7
 Riprap Size Particle Erosion

Design Guidelines (continued)

Design Procedure
(continued)

PROJECT _____ DESCRIPTION _____	Prepared by/Date: _____ / _____ Checked by/Date: _____ / _____ Sheet _____ of _____
------------------------------------	---

WIND SPEED (mph)	FETCH (mi)	H ₀ (ft) ①	θ	R _v /H ₀ ②	CORR. FACTOR ③	R _v (ft) ④	D ₅₀ (ft) ⑤

DEFINITION SKETCH

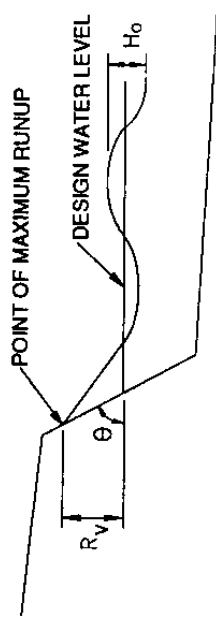

AASHTO GRADATION: SIZE (ft) _____

PERCENT FINER	100
	50
	5-10

REVETMENT THICKNESS:

2D₅₀ _____ ft

D₁₀₀ _____ ft

USE _____ ft

RIPRAP SIZE: _____ ft

CLASS _____

- ① USE CHART 6 OR OTHER METHOD
- ② USE CHART 9
- ③ SEE TABLE 9
- ④ ①-②-③
- ⑤ USE CHART 7

Figure 17-8
Riprap Size Wave Erosion

Step 2: Determine design discharge.

Step 3: Develop design cross section(s).

Note: The rock sizing procedures described in the following steps are designed to prevent riprap failure from particle erosion.

Step 4: Compute design water surface.

- a. When evaluating the design water surface, Manning's "n" should be estimated. If a riprap lining is being designed for the entire channel perimeter, an estimate of the rock size may be required to determine the roughness coefficient "n" (Section 17.6.6).
- b. If the design section is a regular trapezoidal shape, and flow can be assumed to be uniform, use design procedures from the Open Channels Chapter.
- c. Design section is irregular or flow is not uniform, backwater procedures must be used to determine the design water surface.
- d. Any backwater analysis conducted must be based on conveyance weighing of flows in the main channel, right bank and left bank.

Step 5: Determine design average velocity and depth.

- a. Average velocity and depth should be determined for the design section in conjunction with the computations of step 4. In general, the average depth and velocity in the main flow channel should be used.
- b. If riprap is being designed to protect channel banks, abutments, or piers located in the floodplain, average floodplain depths and velocities should be used.

Step 6: Compute the bank angle correction factor K_1 (Equation 17.5).

Rock Sizing

Step 7: Determine riprap size required to resist particle erosion (Equation 17.4).

- a. Initially assume no corrections.

- b. Evaluate correction factor for rock riprap specific gravity and stability factor ($C = C_{sg}C_{sf}$).
- c. If designing riprap for piers or abutments see Bridge Chapter.

Step 8: If entire channel perimeter is being stabilized, and an assumed D_{50} was used in determination of Manning's "n" for backwater computations, return to step 4 and repeat steps 4 through 7.

Step 9: If surface waves are to be evaluated:

- a. Determine significant wave height (see Coastal Chapter).
- b. Determine rock size required to resist wave action (Equation 17.11).

Step 10: Select final D_{50} riprap size, set material gradation, and determine riprap layer thickness.

Revetment Detail Design

Step 11: Determine longitudinal extent of protection required (section 17.6.7).

Step 12: Determine appropriate vertical extent of revetment (section 17.6.7).

Step 13: Design filter layer.

- a. Determine appropriate filter material size, and gradation.
- b. Determine layer thickness.

Step 14: Design edge details (flanks and toe).

17.7.2 Wire-Enclosed Rock

As described in Section 17.5.3 wire-enclosed rock (gabion) revetments consist of rectangular wire mesh baskets filled with rock. The most common types of wire-enclosed revetments are mattresses and stacked blocks. The wire cages which make up the mattresses and gabions are available from commercial manufacturers. If desired, the wire baskets can also be fabricated from available wire fencing materials.

Rock and wire mattress revetments consist of flat wire baskets or units filled with rock that are laid end to end and side to side on a prepared channel bed and/or bank. The individual mattress units are wired together to form a continuous revetment mattress

Stacked block gabion revetments consist of rectangular wire baskets which are filled with stone and stacked in a

stepped-back fashion to form the revetment surface.

They are also commonly used at the toe of embankment slopes as toe walls which help to support other upper bank revetments and prevent undermining.

The rectangular basket or gabion units used for stacked configurations are more equidimensional than those typically used for mattress designs. That is, they typically have a square cross section. Commercially available gabions used in stacked configurations are available in various sizes but the most common have a 3-ft width and thickness. Conceptually, the gabion units for stacked block configurations could be fabricated from available fencing materials. However, the labor-intensive nature of such an installation makes it impractical in most cases. Therefore, only commercially available units are considered in the following sections.

Design Guidelines for Mattresses

Components of a rock and wire mattress design include layout of a general scheme or concept, bank and foundation preparation, mattress size and configuration, stone size, stone quality, basket or rock enclosure fabrication, edge treatment, and filter design. General design guidance is provided below, however, design of mattresses shall be consistent with manufacturer's recommendations.

General

Rock and wire mattress revetments can be constructed from commercially available wire units as illustrated in the details of Figures 17-9 and 17-10, or from available wire fencing material as illustrated in Figure 17-11. The use of commercially available basket units is the most common practice, and is also usually the least expensive approach.

Design Guidelines
For Mattresses
(continued)

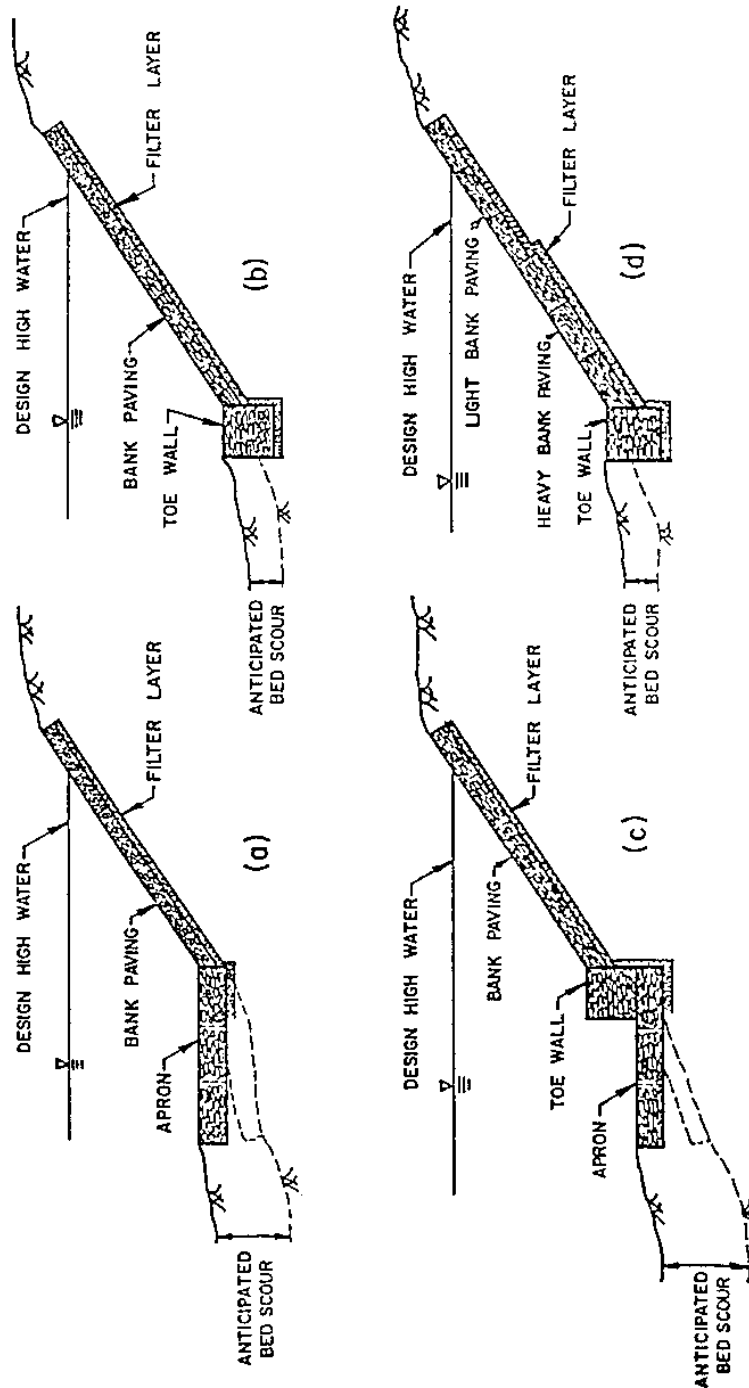

Figure 17-9
Rock and Wire Mattress Configuration:
(a) mattress with toe apron;
(b) mattress with toe wall;
(c) mattress with toe wall and apron; and
(d) mattress of variable thickness with toe.

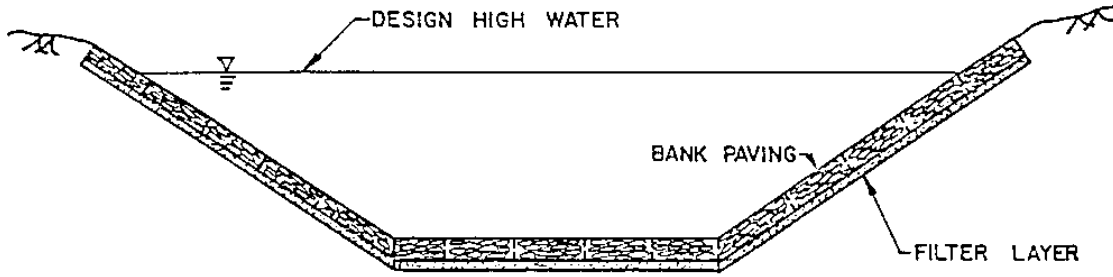

Figure 17-10
 Rock and Wire Mattress Installation Covering The Entire Channel Perimeter

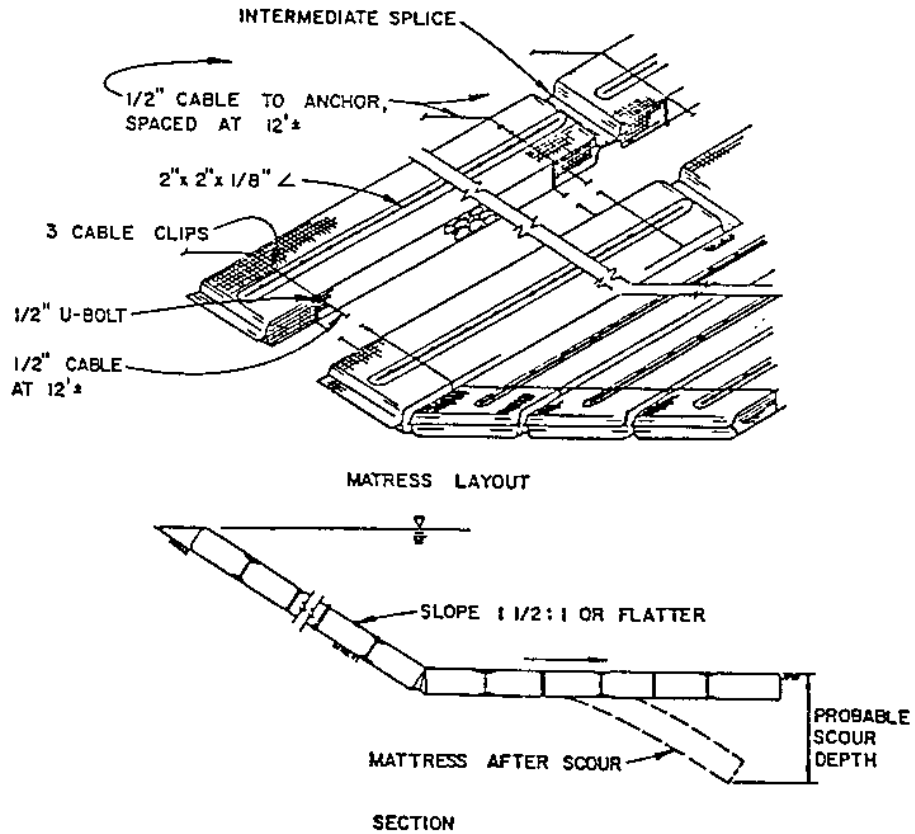

Figure 17-11
 Typical Detail of Rock and Wire Mattress Constructed from Available Wire Fencing Materials

Rock and wire mattress revetments can be used to protect either the channel bank (as illustrated in the section of Figure 17-9) or the entire channel perimeter (Figure 17-10). When used for bank protection, rock and wire mattress revetments consist of two distinct sections: a toe section and upper bank paving (see Figure 17-9). As illustrated in Figure 17-9, a variety of toe designs can be used. Emphasis in design should be placed on toe design, and filter design. These designs are detailed later.

Bank and Foundation Preparation

Channel banks should be graded to a uniform slope. The graded surface, either on the slope or on the stream bed at the toe of the slope on which the rock and wire mattress is to be constructed, should not deviate from the specified slope line by more than 6 inches.

All blunt or sharp objects (such as rocks or tree roots) protruding from the graded surface should be removed.

Edge Treatment

The edges of rock and wire mattress revetment installations (the toe, head, and flanks) require special treatment to prevent damage from undermining. Of primary concern is toe treatment. Figure 17-9 illustrates several possible toe configurations. If a toe apron is used, its projection should be 1.5 times the expected maximum depth of scour in the vicinity of the revetment toe. In areas where little toe scour is expected, the apron can be replaced by a single-course gabion toe wall which helps to support the revetment and prevent undermining. In cases where an excessive amount of toe scour is anticipated, both an apron and a toe wall can be used.

To provide extra strength at the revetment flanks, it is recommended that mattress units having additional thickness be used at the upstream and downstream edges of the revetment (see Figure 17-12). It is further recommended that a thin layer of topsoil be spread over the flank units to form a soil layer to be seeded when the revetment installation is complete. The head of rock and wire mattress revetments can usually be terminated at grade as illustrated in Figure 17-9.

Filter Design

Individual mattress units will act as a crude filter as well as a pavement unit when filled with overlapping layers of hand-size stones. However, it is recommended that the need for a filter be investigated, and if necessary, a layer of permeable membrane cloth

(geotextile) woven from synthetic fibers, or a 4- to 6-inch layer of gravel be placed between the silty bank and the rock and wire mattress revetment to further inhibit washout of fines.

Construction

Construction details for rock and wire mattresses vary with the design and purpose for which the protection is provided. Typical details are illustrated in Figures 17-9 through 17-11. Rock and wire mattress revetments may be fabricated where they are to be placed, or at an off-site location. Fabrication at an off-site location requires that the individual mattress units be transported to the site; in this case extreme care must be taken so that moving and placing the baskets does not damage them by breaking or loosening strands of wire or ties, or by removing any of the galvanizing or PVC coating. Because of the potential for damage to the wire enclosures, off-site fabrication is not recommended.

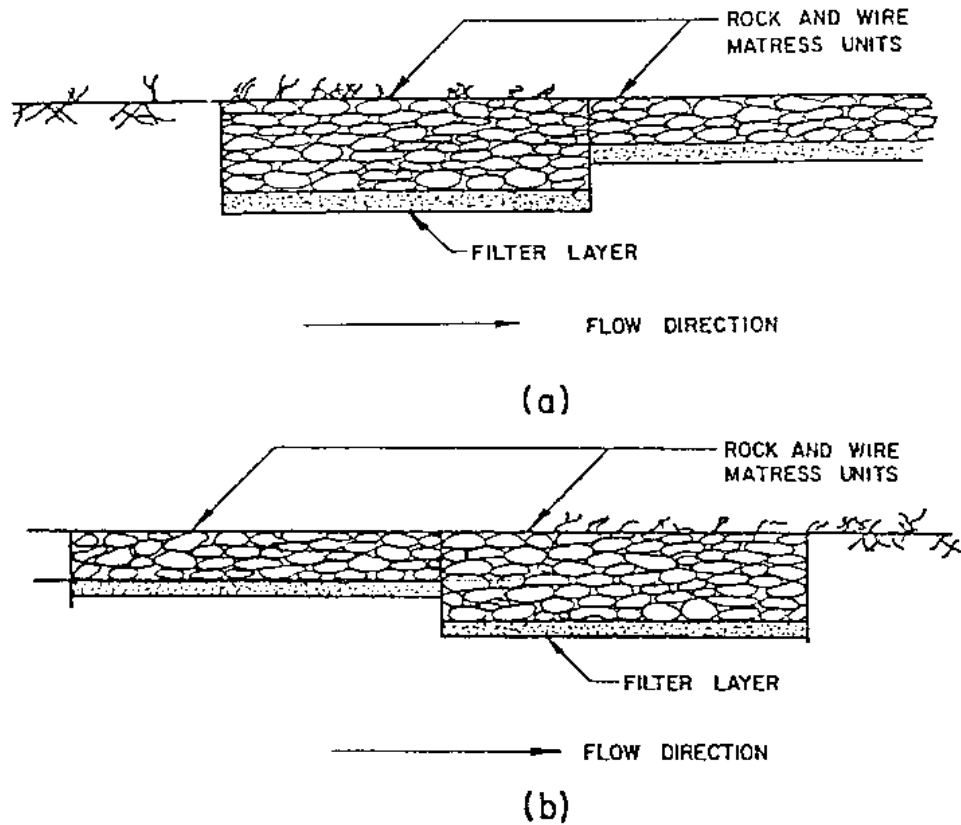

Figure 17-12

**Flank Treatment For Rock And Wire Mattress
Designs: (a) upstream face; (b) downstream face**

Design Guidelines for Stacked Block Gabions

Components of stacked gabion revetment design include layout of a general scheme or concept, bank and foundation preparation, unit size and configuration, stone size and quality, edge treatment, backfill and filter considerations, and basket or rock enclosure fabrication. General design guidance is provided below, however, design of mattresses shall be consistent with manufacturer's recommendations.

General

Stacked gabion revetments are typically used instead of gabion mattress designs when the slope to be protected is greater than 1.5:1 or when the purpose of the revetment is for flow training. They can also be used as

retaining structures when space limitations prohibit bank grading to a slope suitable for other revetments. Typical design schemes include flow training walls, Figure 17-13(a), and low or high retaining walls, Figures 17-13(b and c) respectively.

Stacked gabion revetments must be based on a firm foundation. The foundation or base elevation of the structure should be well below any anticipated scour depth. Additionally, in alluvial streams where channel bed fluctuations are common, an apron should be used as illustrated in Figures 13(a and b). Aprons are also recommended for situations where the estimated scour depth is uncertain.

Typical design configurations include flow training walls and structural retaining walls. The primary function of flow training walls (Figure 13(a)) is to establish normal channel boundaries in rivers where erosion has created a wide channel, or to realign the river when it is encroaching on an existing or proposed structure. A stepped-back wall is constructed at the desired bank location; counterforts are installed to tie the walls to the channel bank at regular intervals as illustrated. The counterforts are installed to form a structural tie between the training wall and the natural stream bank, and to prevent overflow from scouring a channel behind the wall. Counterforts should be spaced to eliminate the development of eddy or other flow currents between the training wall and the bank which could cause further erosion of the bank. The dead water zones created by the counterforts so spaced will encourage sediment deposition behind the wall which will enhance the stabilizing characteristics of the wall.

Retaining walls can be designed in either a stepped-back configuration as illustrated in Figures 17-13 (b and c), or a batter configuration as illustrated in Figure 17-13(d). Structural details and configurations can vary from site to site.

Gabion walls are gravity structures and their design follows standard engineering practice for retaining structures. Design procedures are available in standard soil mechanics texts as well as in gabion manufacturer's literature.

Edge Treatment

The flanks and toe of stacked block gabion revetments require special attention. The upstream and downstream flanks of these revetments should include counterforts, see Figure 17-13(a).

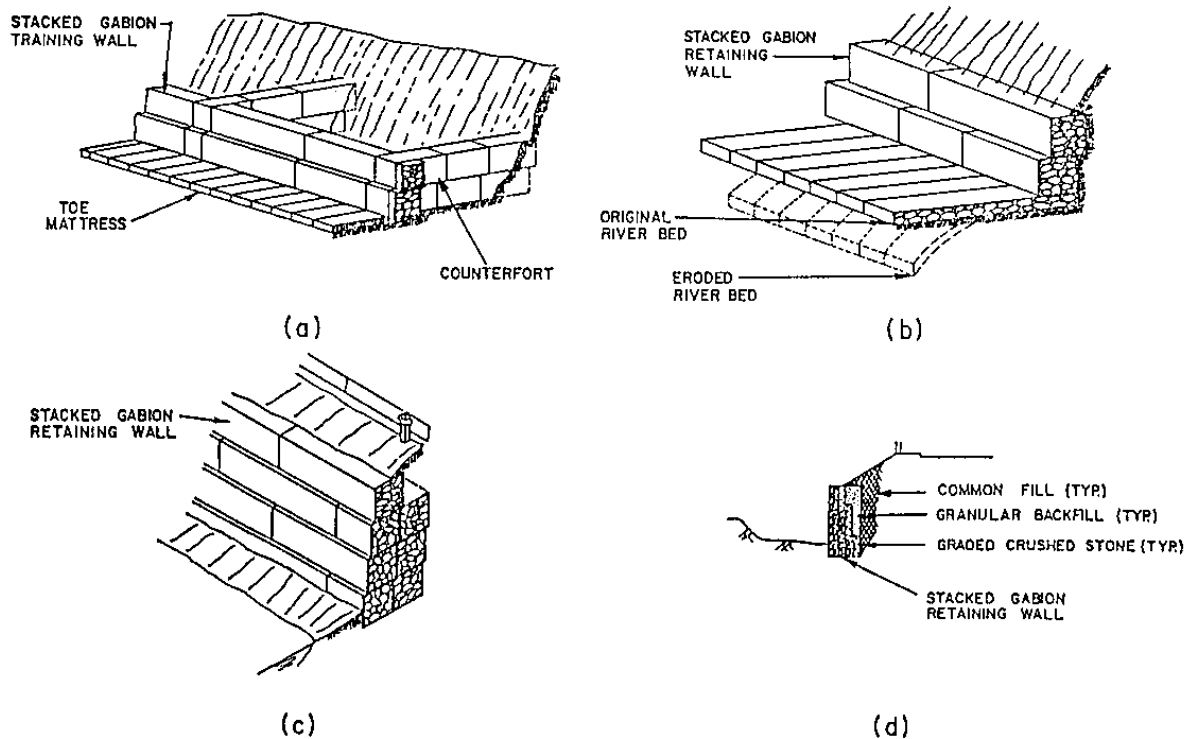

Figure 17-13

- Typical Stacked Block Gabion Revetment Details:**
(a) training wall with counterforts
(b) stepped back low retaining wall with apron
(c) high retaining wall, stepped-back configuration;
(d) high retaining wall, batter type.

The counterforts should be placed 12 to 18 feet from the upstream and downstream limits of the structure, and should extend a minimum of 12 feet into the bank. The toe of the revetment should be protected by placing the base of the gabion wall at a depth below anticipated scour depths. In areas where it is difficult to predict the depth of expected scour, or where channel bed fluctuations are common, it is recommended that a mattress apron be used. The minimum apron length should be equal to 1.5 times the anticipated scour depth below the apron. This length can be increased in proportion to the level of uncertainty in predicting the local toe scour depth.

Construction

Construction details for gabion installations typically vary with the design and purpose for which the protection is being provided. Several typical design schematics were presented in Figures 17-13. Design details for a typical stepped-back design and a typical batter design are presented in Figure 17-14.

As with mattress designs, fabrication and filling of individual basket units can be done at the site, or at an off-site location. The most common practice is to fabricate and fill individual gabions at the design site. Because of the potential for damage to the wire enclosures, off-site fabrication is not recommended.

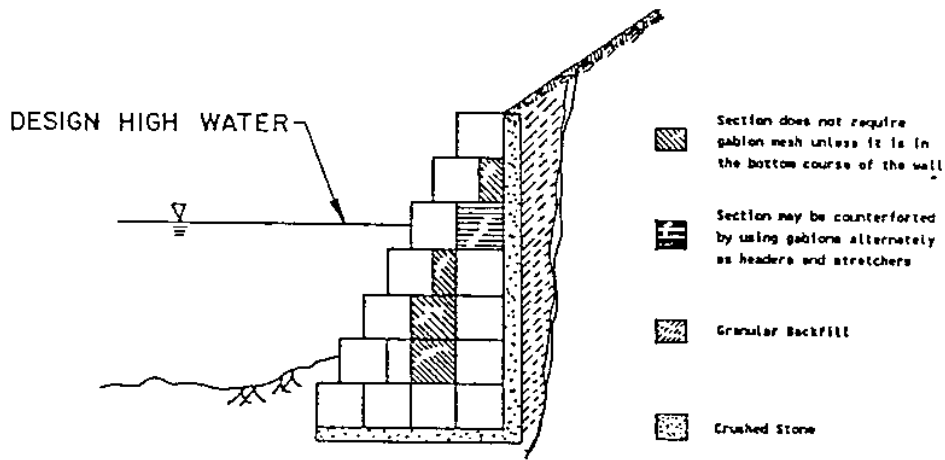

(a)

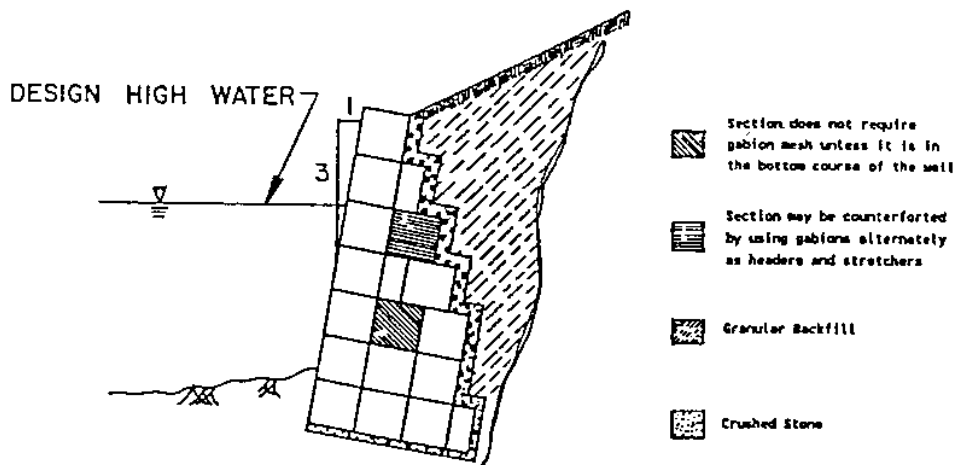

(b)

Figure 17-14
Section Details: (a) stepped back and (b) battered gabion retaining walls

17.7.3 Pre-cast Concrete

Pre-cast concrete block revetments consist of pre-formed sections which interlock with each other, are attached to each other, or butt together to form a continuous blanket or mat. The concrete blocks which make up the mats differ in shape and method of articulation, but share certain common features. These features include flexibility, rapid installation, and provisions for the establishment of vegetation within the revetment.

Block Designs

Pre-cast concrete block designs come in a number of shapes and configurations. Figures 17-15 through 17-19 illustrate several commercially available concrete block designs. Note that other manufacturers and designs are available.

Pre-cast revetments are bound using a variety of techniques. In some cases the individual blocks are bound to rectangular sheets of filter fabric (referred to as fabric carrier). Other manufacturers use a design which interlocks individual blocks. Other units are simply butted together at the site. The most common method is to join individual blocks with wire cable or synthetic fiber rope.

Pre-cast Concrete Design Guidelines

Components of a pre-cast concrete block revetment design include layout of a general scheme or concrete, bank preparation, mattress and block size, slope, edge treatment, filter design, and surface treatment. General design information is provided below in each of these areas. Consult the manufacturer for specifics.

As illustrated in Figure 17-15 through Figure 17-19, pre-cast block revetments are placed on the channel bank as continuous mattresses. Emphasis in design should be placed on anchorage, toe design, edge treatment, and filter design.

Bank Preparation

Bank preparation is extremely important. Channel banks should be graded to a uniform slope. Any large boulders, roots, and debris should be removed from the bank prior to final grading. Also, holes, soft areas, and large cavities should be filled. The graded surface, either on the slope or on the stream bed at the toe of the slope on which the revetment is to be constructed, should be true to line and grade. Light compaction of the bank surface is recommended to provide a solid foundation for the mattress.

Mattress and Block Size

The overall mattress size is dictated by the longitudinal and vertical extent required of the revetment system. Articulated block mattresses are assembled in sections prior to placement on the bank; individual mattress should be constructed to a size that is easily handled on site by available construction equipment. The size of individual blocks is quite variable from manufacturer to manufacturer. In addition, individual manufacturers usually have several standard sizes of a particular block available. Manufacturer's literature should be consulted when selecting an appropriate block size for a given hydraulic condition.

Design Guidelines (continued)

Design Guidelines
(continued)

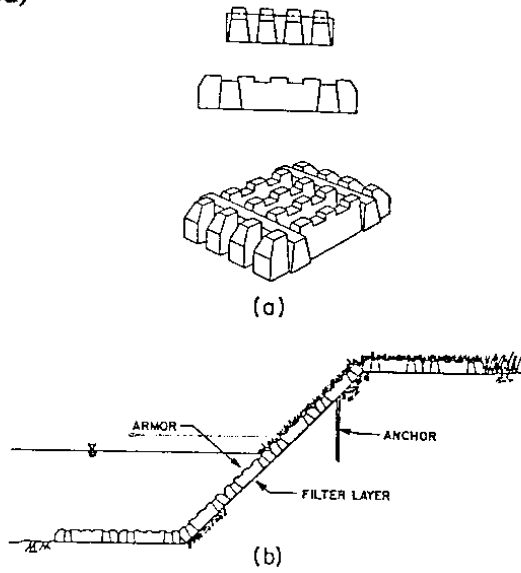

Figure 17-15
Monoslab Revetment (a) block detail and (b) revetment detail

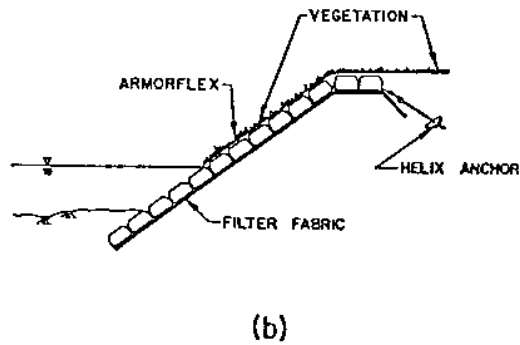
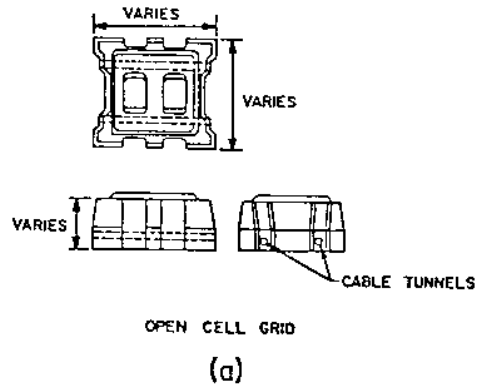

Figure 17-16
Armorflex (a) block detail and (b) revetment configuration

Design Guidelines (continued)

Design Guidelines
(continued)

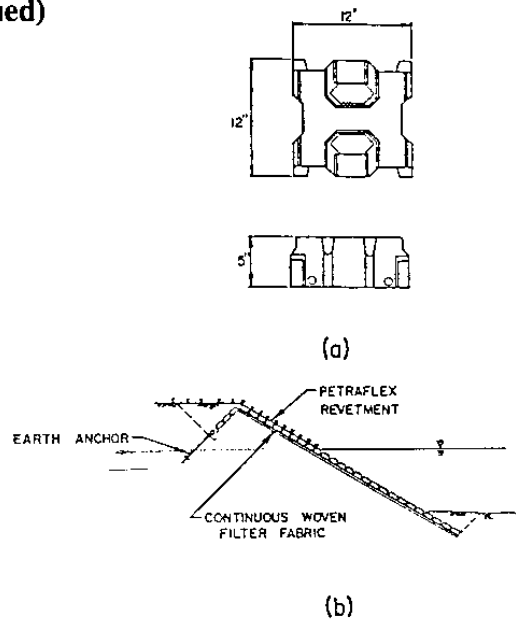

Figure 17-17
Petraflex (a) block detail and (b) revetment configuration

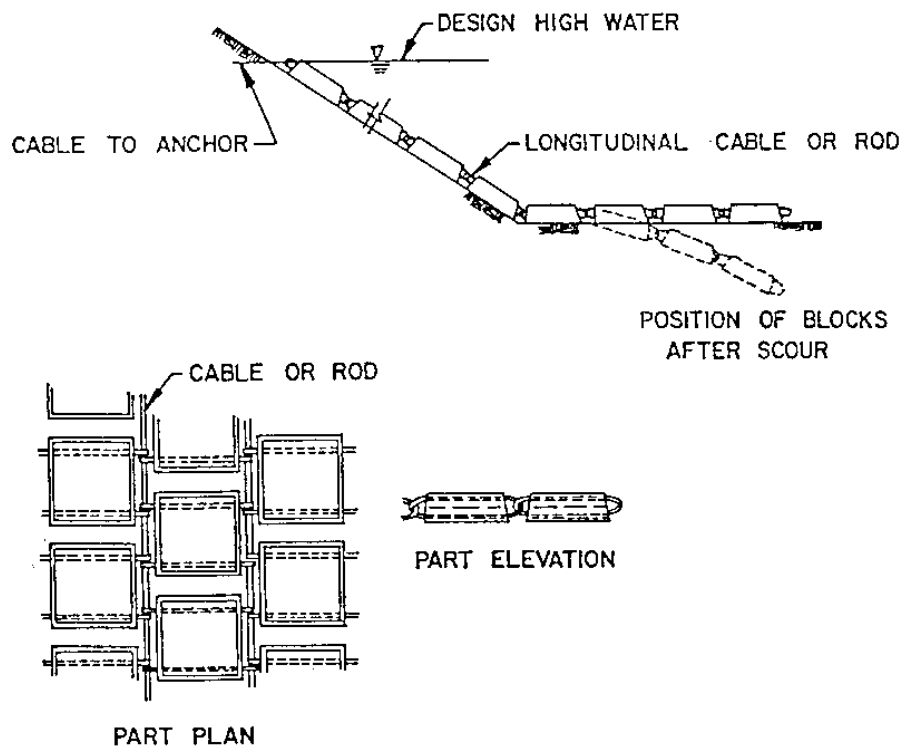
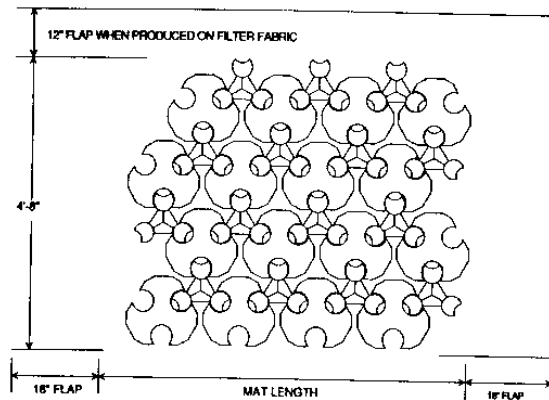

Figure 17-18
Articulated Concrete Revetment



**Figure 17-19
Tri-lock Revetment**

Slope

Articulated pre-cast block revetments can be used on bank slopes up to 1.5H:1V. However, an anchor must be used at the top of the revetment to secure the system against slippage (see Figures 17-17 and 17-18).

Pre-cast block revetments that are assembled by simply butting individual blocks end to end with no physical connection should not be used on slopes greater than 3:1.

Edge Treatment

The edges of pre-cast block revetments (the toe, head, and flanks) require special treatment to prevent undermining. Of primary concern in the design of mattress revetments is the toe treatment. Two toe treatments have been used: an apron design as illustrated in Figures 17-15 and 17-18, and a toe trench design as illustrated in Figures 17-16 and 17-17. As a minimum, toe aprons should extend 1.5 times the anticipated scour depth in the vicinity of the bank toe. If a toe trench is used, the mattress should extend to a depth greater than the anticipated scour depth in the vicinity of the bank toe.

Two alternatives have also been used for edge treatments at the top and flanks. The edges can be terminated at-grade (Figures 17-15, 17-16, and 17-18) or in a termination trench. Termination trenches are recommended in environments subject to significant erosion (silty/sandy soils, and high velocities), or where

failure of the revetment would result in significant economic loss. Termination trenches provide greater protection against failure from undermining and outflanking than do at-grade terminations. However, in instances where upper bank erosion or lateral outflanking is not expected to be a problem, grade terminations may provide an economic advantage.

For articulated designs, earth anchors should be placed at regular intervals along the top of the revetment (see Figures 17-16 and 17-17). Anchors are spaced based on soil type, mat size, and the size of the anchors. See manufacturer's literature for recommended spacings.

Filter

Prior to installing the mats, a geotextile filter fabric should be installed on the bank to prevent bank material from leaching through the openings in the mattress structure. Although a fabric filter is recommended, graded filter material can be used if it is properly designed and installed to prevent movement of the graded material through the protective mattress.

Surface Treatment

The spaces between and within individual blocks located above the low water line may be filled with earth and seeded so that natural vegetation can be established on the bank (see Figures 17-16 and 17-17). This treatment enhances both the structural stability of the embankment and its aesthetic qualities.

Construction

Schematics of the types of pre-cast block revetments discussed above are provided in Figures 17-15 through 17-19. More detailed design sketches and information are available from individual manufacturers. Manufacturers also have available information on construction procedures. Some manufacturers will provide on-site advice and assistance in the installation of their systems.

Articulated pre-formed block revetments can be installed by construction crews using conventional construction equipment wherever a dragline or crane can be maneuvered. Construction procedures for most pre-formed block revetments are similar.

17.7.4 Grouted Rock

Grouted rock revetment consists of rock slope-protection having voids filled with concrete grout to form a monolithic armor. See section 17.5.5 for additional descriptive information and general performance characteristics for grouted rock. This method is not commonly used in Alaska.

Grouted Rock Design Guidelines

Components of grouted rock riprap design include layout of a general scheme or concept, bank preparation, bank slope, rock size and blanket thickness, rock grading, rock quality, grout quality, edge treatment, filter design, and pressure relief.

Grouted riprap designs are rigid monolithic bank protection schemes. When complete they form a continuous surface. Refer to HEC-11 for specific design guidelines.

17.7.5 Concrete Slope Pavement

Concrete slope pavement revetments are cast in place, or precast and set in place on a prepared slope to provide a continuous, monolithic armor for bank protection. Cast-in-place designs are the most common of the two design methods. For additional descriptive information and general performance characteristics of concrete pavement (see Section 17.5.6).

Design Guidelines

Components of concrete pavement revetment design include layout of a general scheme, bank and foundation preparation, bank slope, pavement thickness, pavement reinforcement, edge treatment, stub walls, filter design, pressure relief, and concrete quality. Refer to HEC-11 for specific design guidelines.

17.7.6 Grouted Fabric Slope Paving

Grouted fabric-formed revetments are a relatively new development for use on earth surfaces subject to erosion. They have been used as an alternative to traditional revetments such as concrete liners or riprap on reservoirs, canals, and dikes.

Grouted fabric-formed revetments are made by pumping a highly fluid structural grout, often referred to as "fine aggregate concrete," into an insitu envelope consisting of a double-layer synthetic fabric. During filling, excess mixing water is squeezed out through the highly permeable fabric substantially reducing the water/cement ratio with consequent improvement in the quality of the hardened concrete. A major advantage of this type revetment is that fabric formed revetments may be as easily assembled underwater as in a dry location.

Types

There are three commonly used types of fabric-formed revetments.

Type 1 Two layers of nylon fabric are woven together at 5 to 10 inch centers as indicated in Figure 17-20. These points of attachment serve as filter points to relieve hydrostatic uplift caused by percolation of ground water through the underlying soil. The finished revetment has a deeply cobbled or quilted appearance. Mat thicknesses typically average from 2 to 6 inches.

Type 2 Two layers of nylon or polypropylene woven fabric are joined together at spaced centers by means of interwoven tie cords, the length of which controls the thickness of the finished revetment. Plastic tubes may be inserted through the two layers of fabric prior to grout injection to provide weep holes for relief of hydrostatic uplift. The finished revetment is of relatively uniform cross section and has a lightly pebbled appearance as shown in Figure 17-21. Mat thickness typically average from 2 to 10 inches.

Type 3 Two layers of nylon fabric are interwoven in a variety of rectangular block patterns, the points of interweaving serving as hinges to permit articulation of the hardened concrete blocks. Revetments are reinforced by steel cables or nylon rope threaded between the two layers of fabric prior to grout injection and remain embedded in the hardened cast-in-place blocks. Block thickness is controlled by spacer cords in the middle of each block.

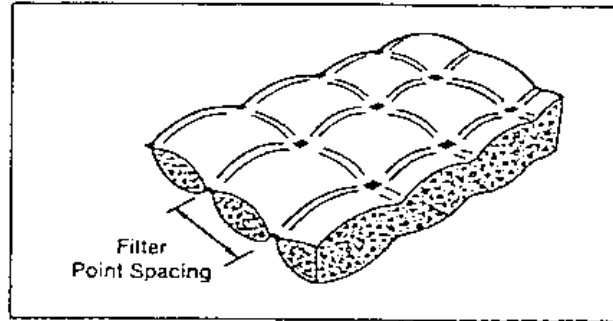

Figure 17-20
Type 1 Grouted Fabric-Formed Revetment

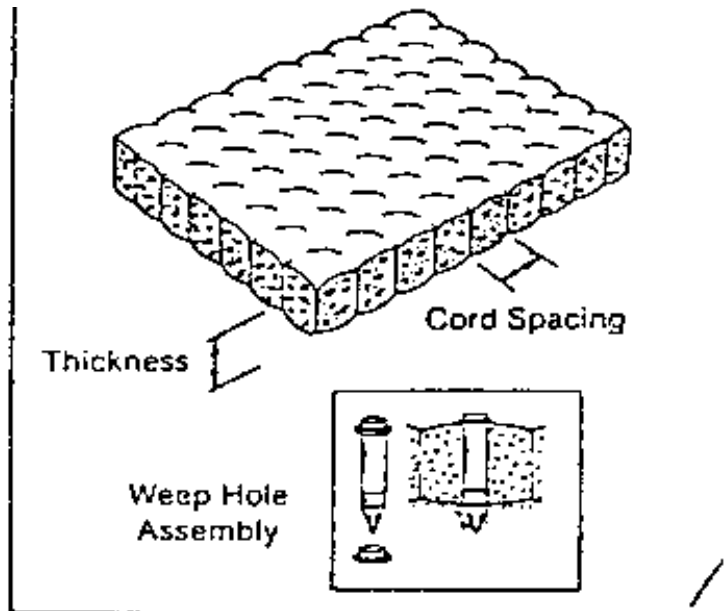

Figure 17-21
Type 2 Grouted Fabric-Formed Revetment

Design Guidelines

The specially woven fabric for grouted fabric formed revetments are manufactured by several different companies. The designer should consult with the manufacturer's literature for designing and selecting the appropriate type of material and thickness for a given hydraulic condition.

17.7.7 Sand-Cement Bags

Sand cement bags generally consist of a dry mix of sand and cement placed in a burlap or other suitable bag. They require firm support from the protected bank. Usually a filter fabric is placed underneath this type of riprap. Adequate protection of the terminals and toe is essential. The riprap has little flexibility, low tensile strength and is susceptible to ice damage and damage particularly on flatter slopes where the area of contact between the bags is less.

Design Guidelines

Concrete riprap in bags generally consists of approximately $2/3$ cubic foot of class C concrete ($3 \frac{1}{2}$ bags cement per yard) in a burlap bag or in a cement sack. Each bag should be tied if in cement sacks or the top folded around the bag if in burlap sacks. This type of riprap provides a heavy protection regardless of the requirements of the site. The riprap has little flexibility, low tensile strength and is susceptible to damage from ice. It requires firm support from the protected bank and usually requires a filter blanket underneath the riprap. Adequate protection of the terminals and toe is essential. The toe trench must end in firm support and extend below the depth of anticipated scour. Details of terminal protection and cutoff stubs are shown in Figure 17-22.

The bags make close contact with each other and some bond is secured between the bags by the cement mortar leaking through the porous bags. Flat slopes reduce the area of contact between the sacks and thus bond is less. Slopes of the protected embankment are generally 1.5:1. If the slopes are as flat as 2:1, all sacks after the bottom row should be laid as headers (long way of sack in line with the slope) rather than as stretchers (long way at right angles to slope direction).

Concrete riprap in bags is sometimes placed as a dry mix. The riprap is thoroughly wetted as the work progresses. Some bond between sacks is probably lost by this method, but it allows the sacks to be filled at a convenient location and brought to the construction site. A well graded filter blanket is essential to drain

the water that is added during construction. Refer to HEC-11 for specific design guidelines.

Design Guidelines
(continued)

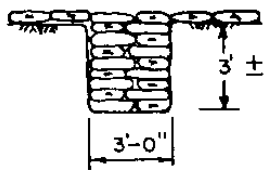
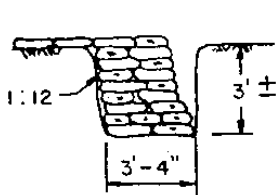
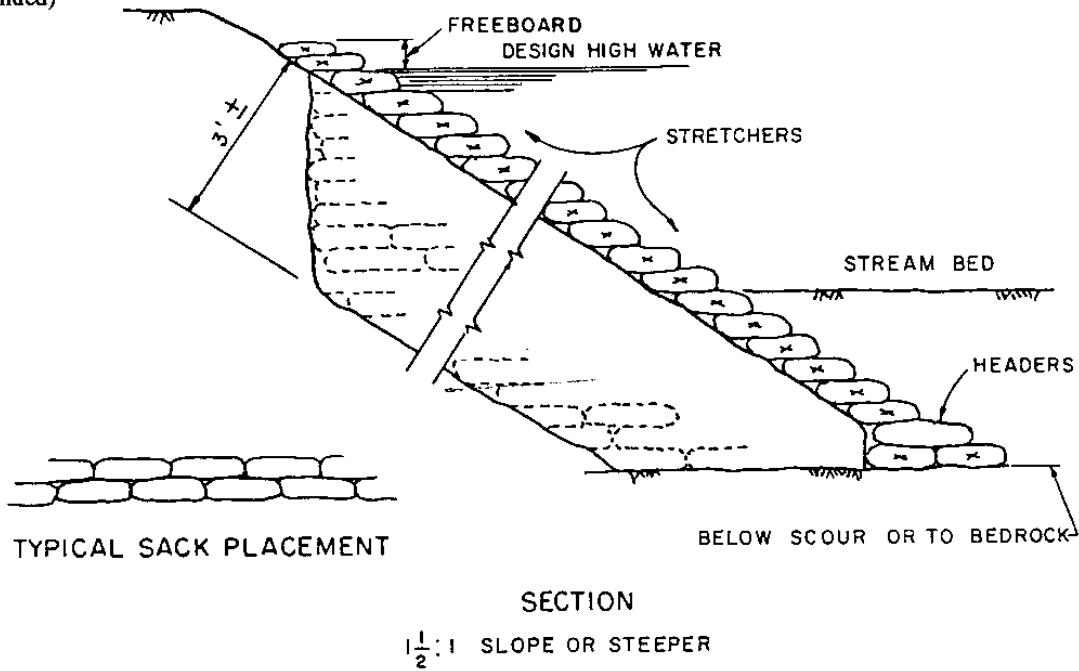

CUTOFF STUBS AT
30' INTERVALS

NOTE
DIMENSIONS AND DETAILS
SHOULD BE MODIFIED AS
REQUIRED

TERMINAL
SECTION

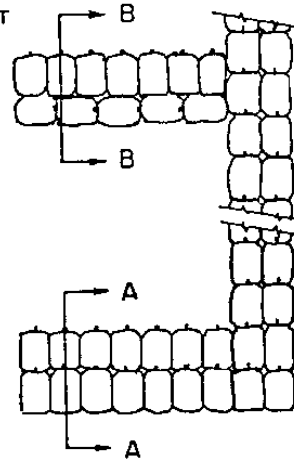

DETAILS

Figure 17-22
Typical Section and Details Of Sacked Concrete Slope Protection

17.8. References

State of California, Department of Transportation, November 1970. Bank and Shore Protection in California Highway Practice.

U. S. Corps of Engineers, April 1985. Design of Coastal Revetments, Seawalls, and Bulkheads. Engineering Manual EM-1110-2-1614.

U. S. Department of Transportation, Federal Highway Administration. 1989. Design of Riprap Revetment. Hydraulic Engineering Circular No. 11.